

ULTRA PLUS⁺

UP-12-5800 SERIES ULTRAFILTRATION SYSTEM

APPLICABLE MODELS:

UP-12-5800-FULL

OWNER'S MANUAL & INSTALLATION GUIDE



PLEASE READ THIS MANUAL CAREFULLY BEFORE ATTEMPTING INSTALLATION. FAILURE TO FOLLOW THESE INSTRUCTIONS MAY VOID YOUR WARRANTY, CAUSE INJURY, OR RESULT IN PROPERTY DAMAGE.

Congratulations on the purchase of your UltraPlus+ Ultrafiltration (UF) water treatment system.

This manual is designed to provide owners, installers, and service technicians with detailed information about the installation, start-up, and operation of the UltraPlus+ system.

The brain of the UltraPlus+ system is the Fleck 5800XTR2 control valve. It is manufactured by one of the world's largest and most respected water treatment companies, Pentair. The Fleck 5800 control valve is well respected for its reliability, serviceability, simple operation, extensive features, and convenient color LCD touch-screen display. The Fleck 5800XTR2 valve/controller service manual is also included with your system. It contains important information regarding the operation of your Fleck 5800 XTR2 control valve.

Your water treatment system is designed to offer low maintenance operation. The control valve will perform regular maintenance functions automatically. For your convenience, your system has been pre-programmed for you by our technicians. Should you need to change any of the settings, simply follow the instructions provided in this manual. It is highly recommended that you consult your dealer before making any programming changes.

TABLE OF CONTENTS

APPLICATIONS & SPECIFICATIONS	3
OPERATING CONDITIONS	4
BEFORE YOU START	5
SELECT AN INSTALLATION LOCATION	8
PREPARE THE MEMBRANE VESSEL	9
LAYOUT	12
CONNECT PRESSURE TANK ASSEMBLY	12
CONNECT INLET/OUTLET ASSEMBLY	12
CONNECT DRAIN ASSEMBLY	13
PLUMBING CONNECTIONS	14
SOLENOID VALVE CONNECTIONS	15
START UP THE SYSTEM	18
TURN ON THE WATER	20
BACK FLUSH & FORWARD FLUSH	21
SETTING THE TIME OF DAY	21
CHANGING BASIC SETTINGS	22
DIAGNOSTICS	23
MASTER SETTINGS MODE	24
CONTROL OPERATION DURING A POWER FAILURE	25
MAINTENANCE & TROUBLESHOOTING.....	26
WARRANTY INFORMATION	27

APPLICATIONS & SPECIFICATIONS

COMMON APPLICATIONS:

- ✓ Surface and ground water treatment to remove sediment, turbidity, colloids, rock flour, and other fine particulate.
- ✓ Organics and tannin removal (since the molecular weights of tannin molecules vary widely, pilot testing prior to purchase/installation is strongly recommended).
- ✓ Rainwater catchment treatment and gray water recycling.
- ✓ Reverse Osmosis (RO) pre-filter.
- ✓ Pre-filtration for disinfection systems as part of a multi-barrier approach for the treatment of bacteria, viruses, and cysts including cryptosporidium and giardia.*

***Note: This product is not designed, certified, or recommended as a stand-alone microbiological treatment device and should not be applied as a solution for microbiologically unsafe water without additional treatment. If microbiological protection is a treatment objective, we recommend that ultraviolet (UV) disinfection and/or chlorination be applied. The UltraPlus™ system can be used a pre-treatment device to enhance the performance of the disinfection equipment selected by removing sediment and organics that may interfere with optimal disinfection. A Pressure Decay Test (PDT) can be utilized to ensure optimal ongoing pre-filtration performance.**

SPECIFICATIONS:

For optimal filtration, the continuous service flow rate range should not be exceeded. Satisfactory filtration can generally be achieved up to the maximum peak flow rate as long as this level of flow rate is not sustained continuously.

- **Model Number:** UP-12-5800-FULL
- **Membrane Type:** Polysulfone Hollow-Fiber - 4 Bundles
- **Membrane Flow:** Outside-to-Inside
- **Micron Rating:** 0.02 Microns Absolute
- **Molecular Weight Cut-Off:** 100,000 Daltons (Da)
- **Operating Temperature Range:** 35 to 100 degrees F***
- **Operating Pressure Range:** 10 to 100 PSI*
- **Max. (Peak) Flow Rate:** 12 GPM (@ 25 C and 60 PSI)**
- **Continuous Service Flow Rate:** up to 10 GPM
- **Recommended Back Flush:** 2 GPM for 5 minutes, daily
- **Typical Membrane Life:** 5-10 years
- **Inlet / Outlet:** 1" MNPT
- **Drain:** 3/4" MNPT

* Contact dealer for advice for applications with < 30 PSI. If your water pressure is greater than 100 PSI, you should install a pressure reduction valve prior to installing this product.

** Multiple units can be installed in parallel flow configuration for higher flow rate applications.

*** The unit cannot be subjected to freezing conditions. Severe damage to the system or your property could occur.

COMPONENT VALIDATIONS:

Component	Country Of Manufacture	Validation
UF Membrane Elements	France	NSF/ANSI Standard 61
Membrane Pressure Vessel	USA	NSF/ANSI Standard 44*
Control Valve	USA	NSF/ANSI Standard 44* & 372
Backwash Pressure Tank	USA	NSF/ANSI Standard 61
Fittings and Piping**	U.K. and Canada	NSF/ANSI Standard 61 (Fittings)

*Material & Structural Integrity Requirements

**Quick Installation Kits

OPERATING CONDITIONS

The following list provides guidance on the feed water conditions required for successful operation of your ultrafiltration system. Use of this equipment outside of these operating conditions may adversely affect the performance of your system, may void your warranty, and can result in membrane clogging, water leaks, and/or property damage.

Water should be pre-treated as necessary to ensure the following conditions are met:

- **Sediment Pre-Filtration:** 5 microns or less
- **Chlorine:** 1.0 ppm (mg/l) maximum for continuous flow (up to 2,000 ppm for cleaning only)
- **Iron:** less than 0.30 ppm (mg/l)
- **Manganese:** less than 0.05 ppm (mg/l)
- **Silt Density Index:** less than 6.0
- **pH:** 3 to 11

Recommended Pre-Filter Options:

- HomePlus WH-20x1 Whole House Filter Package + Hydronix SDC-45-2005, Pentek DGD-5005-20 or VIQUA CMB-520-HF Cartridge
- Pentek PBH-420-1 Bag Filter Housing + Pentek BP-420-5 Bag Filter
- ClearPlus WH1B+-HF high Flow Series 5 Micron Whole House Sediment Filter Package
- HomePlus MicroTurb or Other Similar Backwashable NextSand Filter

CONFIRM THAT YOUR WATER CONDITIONS MEET THE ABOVE SPECIFICATIONS BEFORE COMMENCING THE INSTALLATION PROCESS. IF IN DOUBT, CALL YOUR DEALER FOR ADVICE. INSTALLED UNITS CANNOT BE RETURNED.

BEFORE YOU START



We recommend that you read the entire instructions before commencing the actual installation. While we strongly recommend that a water treatment technician or licensed plumber perform all installation work, a mechanically-inclined homeowner can install this system. In all cases, it is critical that the installation be done in accordance with these instructions and all applicable plumbing and electrical codes. Be sure to obtain all required permits. If these instructions and the applicable codes are in conflict, the relevant plumbing/electrical code should be followed. Equipment failure, personal injury, and/or property damage can result if this equipment is not installed properly or if it used incorrectly.

Back Flush

Where a single system is used on its own, a Back Flush Pressure Tank with a minimum capacity of about 30 gallons is required (minimum drawdown of 10 gallons) so that the system can automatically backwash the membrane on a daily basis using treated water. This keeps the membrane clean and prevents clogging. UP-12-5800-FULL system packages generally include the **Wellmate WM-9** pressure tank. The **Flexcon CSS-35** is also a popular choice and may be supplied with your system in the event of supply chain challenges. The Back Flush Pressure Tank can also provide a small volume of service water during the Back Flush process. It is recommended that the Back Flush be scheduled to occur in the middle of the night when service demands should be zero. If you will commonly need service water during the Back Flush process, a larger Back Flush Pressure Tank is recommended.









Forward Flush

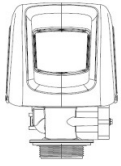

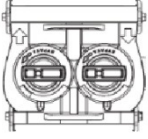

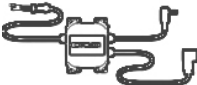

All UltraPlus™ systems are supplied with a Forward Flush kit which performs a short forward flush cycle after each Back Flush cycle. This process offers further protection to your membrane.

Quick Installation Kit

Your system has been supplied with our quick installation kit which enables installers to quickly connect the system to the Back Flush Pressure Tank, etc. This kit uses brand-name quick-connect style fittings and PEX tubing for a tidy, professional-looking installation in a fraction of the time.

Ensure that you have received the following components:

#	Picture	Part Description
1		CONTROL VALVE (FLECK 5800 XTR2)
2		TRANSFOMER
3		BYPASS ASSEMBLY
4		MEMBRANE VESSEL
5		BOTTOM TANK ADAPTER
6		BACK FLUSH PRESSURE TANK (WELLMATE WM-9)
7		BACK FLUSH PRESSURE TANK RETENTION CLIP (BLUE)
8		BACK FLUSH SOLENOID VALVE (1 INCH)
9		BACK FLUSH SOLENOID WIRING KIT

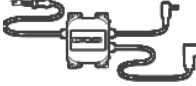
10		INLET/OUTLET ASSEMBLY
11		LOWER TANK ASSEMBLY
12		DRAIN ASSEMBLY
13		PRESSURE TANK ASSEMBLY
14		FORWARD FLUSH TUBE (3/4")
15		PRESSURE TANK TUBE (1")
16		FORWARD FLUSH SOLENOID VALVE (3/4 INCH)
17		FORWARD FLUSH SOLENOID WIRING KIT

The Quick Installation Kit uses various brand-name quick connect fittings for easy assembly. There are 2 styles used:

John Guest Brand Quick Connect

To connect a tube/pipe to a John Guest fitting, unlock the fitting by turning the collet counter-clockwise until the fitting loosens. A small gap will open between the collet and the back of the fitting. Push the tube firmly into the fitting as far as it will go. Turn the collet clockwise until tight to secure the fitting (no gap). Pull out on the tube to ensure a good connection has been made. The pipe can be removed from the fitting by loosening the collet again and depressing the collar evenly while pulling outward on the tube.

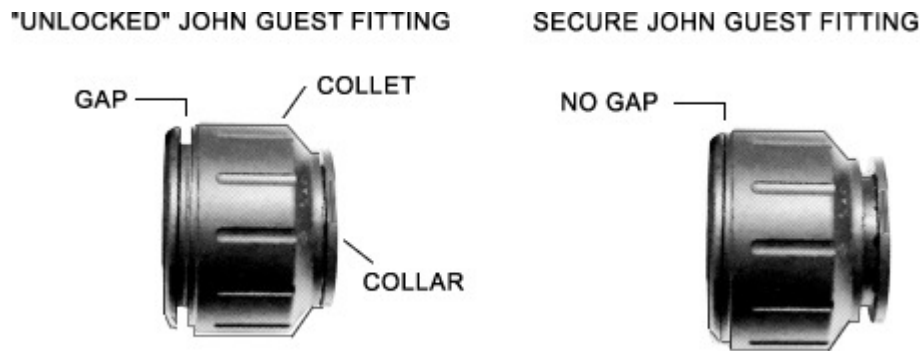

Helpful Tip! When the collet is loosened and the fitting is “unlocked,” the fitting can be rotated as necessary to correctly align the parts and fittings to achieve a perfect installation. It can very handy to unlock/loosen the fittings during installation assembly to allow for the perfect alignment of the parts. **It is very important that all of the fittings are tightened upon completion of the installation process.**

Asco Quick Connect Solenoid Connection

This fitting is used on the outlet side of the Back Flush Solenoid Valve (8). To connect a tube/pipe to this fitting, loosen the connector by turning clockwise until the fitting loosens. Do not remove it completely from the solenoid valve. Push the tube firmly into the fitting as far as it will go. Tighten the connector by turning it clockwise until snug. Pull out on the tube to ensure a good connection has been made. These fittings can be disassembled by unscrewing the connector completely from the solenoid valve and disassembling the fitting piece by piece.

SELECT AN INSTALLATION LOCATION

We recommend interior installation only. The system cannot be allowed to freeze or severe system damage could occur. The system should not be installed in direct sunlight as long-term exposure to UV light could damage components of the system.

This UltraPlus+™ System is designed to be installed on either a gravity fed water system or after a pump and pressure tank. In most cases, the system should be located AFTER the pressure tank, sediment/turbidity pre-filtration, iron filters, water softeners, and tannin filters but BEFORE a UV sterilizer or chlorinator and before the hot water heater. Please discuss with your dealer as there are exceptions.

If you plan to install the UltraPlus+™ system prior to a cistern or pressure tank (not including the Back Flush Pressure Tank (6) included with your UltraPlus+™ System), an alternate installation configuration, control valve programming changes, and/or additional equipment may be required to protect your pump and ensure that the automatic cleaning flushes work properly. Discuss with your dealer before proceeding.

Select a location for installation of your system that is within close proximity to the main incoming water lines of the building. The location should have a firm, level surface with sufficient space for the treatment unit with control valve mounted and the back flush pressure tank. Ensure that there will be enough space surrounding the unit to facilitate maintenance.

You will also need access to at least one standard, non-switched, grounded 120 volt (60 Hz) electrical outlet. The Fleck 5800XTR2 control valve's transformer/power supply comes with a 10 foot long power cord. The back flush solenoid valve and forward flush solenoid valve require a standard electrical outlet for power as well. An extension cord may be used to reach a suitable electrical outlet. If this option is used, ensure that the extension cord is UL/CSA certified and of an appropriate wire gauge for the application.

You will also require a nearby floor drain or standpipe to discharge the drain water from the back flush and forward flush cycles. A drain standpipe for a washing machine, or a floor drain are popular drain options. We recommend that the drain line be connected to a minimum 1 1/2" drain standpipe or floor drain located ideally below the top of the control valve of your system. If possible, the drain should be no farther than 20 feet from the filter system.

Note: Never connect the drain line directly into a drain pipe. Allow an air gap between the drain tubing and waste line to prevent the possibility of back-siphoning. We do not recommend use of a check valve as it may become clogged with contaminants ejected from the system during back/forward flush. A minimum air gap of 2x the diameter of the drain line should be provided. Be sure to adhere to the plumbing code applicable in your area.

PREPARE THE MEMBRANE VESSEL

1. Handle the Membrane Vessel (4) gently to prevent internal damage to the membrane bundles. The Membrane Vessel (4) is shipped with protective plastic caps on the top and bottom. Remove them by unscrewing them counterclockwise. They can be recycled or kept for future use.

2. Apply a thin coat of food-grade silicone lubricant to the large o-ring on the underside of the Bottom Tank Adapter (5). Do NOT use petroleum based lubricants. Attach the Bottom Tank Adapter (5) to the bottom of the Membrane Vessel (4) by screwing it clockwise, hand tight. Excessive force is not required to achieve a good seal. Do NOT use pipe dope or Teflon tape on the threads.
3. The Fleck 5800XTR2 Control Valve (1) can now be attached to the top of the Membrane Vessel (4). Apply a thin coat of food-grade silicone lubricant to the large o-ring on the underside of the base of the Control Valve (1). Do NOT use petroleum based lubricants. You can also add a thin coat of lubricant to the top half inch of the outside of the riser tube inside the top of the Membrane Vessel (4). Screw the Control Valve (1) onto the top of the Membrane Vessel (4) in a clockwise direction – make sure that the riser tube inside the tank inserts into the center hole in the control valve as you screw down the valve. Continue turning until you start to feel resistance. Then grasp the base of the Control Valve (1) and turn 1/4 to 1/2 turn further until snug. Do NOT use pipe dope or Teflon tape on the threads. Excessive force is not required to achieve a good seal.
4. Ensure that the notch in the base of the Membrane Vessel (4) is on the left side of your Membrane Vessel (4) when you are facing the screen on your Control Valve (1). If it is not, first check to make sure that your Control Valve (1) is securely tightened (do not apply excessive force). If it is still not on the left side of your tank, you will need to rotate the base. The base is only pressure fit onto the Membrane Vessel (4). Get a partner to hold the tank while you rotate the base. You can loosen or even remove the base by laying the Membrane Vessel (4) on its side and gently tapping on a wood block on the top edge of the base with a hammer. Be gentle and work around the perimeter of the base. This will loosen the friction between the base and the Membrane Vessel (4) and make it easier to rotate or remove. Once you have the notch in the correct position, push down on the Membrane Vessel (4) to press it securely into the base. If your tank appears to be crooked, the base has likely been knocked out of alignment during this process or during shipping. This can be corrected by picking the Membrane Vessel (4) up and gently tapping it on a hard surface while holding it perpendicular to the floor. A few light taps will generally straighten it out.
5. Connect the Lower Tank Assembly (11) to the Bottom Tank Adapter (5) such that it protrudes out the notch in the base of the Membrane Vessel (4), by screwing it on clockwise (hand tight). Again, excessive force is not required to achieve a good seal. Do NOT use pipe dope or Teflon tape on the threads.
6. Connect the Bypass Assembly (3) to the back of the Control Valve (1). The Bypass Assembly (2) is secured to the control valve using 2 stainless steel clips. Apply a thin film of food grade silicon lubricant to the o-rings on the back of the Control Valve (1). Loosen or remove the screws that hold the 2 stainless steel clips on either side and push the Bypass Assembly (2) onto the back of the Control Valve (1). Secure the 2 clips by tightening the screws. This is a good time to note the inlet and outlet ports of the system. The inlet and outlet ports on the Control Valve (1) are marked with arrows indicating the correct

direction of water flow. When you are looking at the back of the Control Valve (1), the inlet is on the left and the outlet is on the right. Check the corresponding markings on the Bypass Assembly (3) to ensure the correct direction of water flow. The in and out arrows on the Bypass Assembly (3) should be pointing the same direction as the in and out arrows on the outside of the Control Valve (1).



BE VERY CAREFUL TO MAKE SURE YOU PLUMB THE SYSTEM IN THE RIGHT DIRECTION.

LAYOUT

Arrange the assembled Membrane Vessel (4) and the Wellmate WM-9 Back Flush Pressure Tank (6) roughly in accordance with the following floor plan (top view):

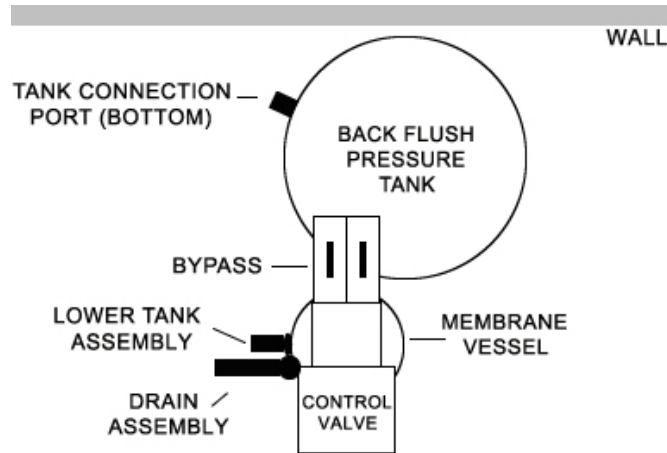

CONNECT PRESSURE TANK ASSEMBLY

1. Attach the Pressure Tank Assembly (13) to the Wellmate WM-9 Back Flush Pressure Tank (6) by pushing the adapter into the fitting at the bottom of the tank and securing it with the blue Back Flush Pressure Tank Retention Clip (7).
2. Connect the Pressure Tank Tube (15) to the John Guest Elbow on the Pressure Tank Assembly (13). Hold the Pressure Tank Assembly (13) in your hand when you push the tube in so that you do not apply pressure on the assembly that may break it.

CONNECT INLET / OUTLET ASSEMBLY

Next, you will attach the Inlet / Outlet Assembly (10) to the back of the Bypass Assembly (3). The side with only the blue pipe and the elbow fittings is the inlet side. The side with the tee fitting is the outlet. In the diagram below, the Inlet / Outlet Assembly (10) is shown upside down so you can see where the Pressure Tank Tube (15) will be connected.



1. Before you secure the Inlet / Outlet Assembly (10) to the back of the Bypass Assembly (3), push the top of the Pressure Tank Tube (15) into the bottom of the tee on the Inlet / Outlet Assembly (10). Adjust the position of the Back Flush Pressure Tank (6) as necessary to ensure that the Pressure Tank Tube (15) is perfectly vertical.
2. Secure the Inlet / Outlet Assembly (10) to the back of the Bypass Assembly (3) using the stainless steel clips in the same manner that you connected the Bypass Assembly (3) to the Control Valve (1).
3. When facing the front of the Control Valve (1), the inlet is on the right side. While it is acceptable for the inlet side of the Inlet / Outlet Assembly (10) to be rotated to any orientation that is convenient, for optimal solenoid valve life and performance, we recommend that it be arranged such that the inlet pipe extends to the right when facing the Control Valve (1) so the solenoid valve is mounted horizontally. Connect the Back Flush Solenoid Valve (8) to the inlet side of the Inlet / Outlet Assembly (10) using the Asco Quick Connect Fitting. Note the directional flow arrow on the solenoid valve. This is extremely important. If installed backwards, the solenoid will not function properly. Also, note that the Back Flush and Forward Flush solenoids look similar but have opposite internal functions. The Back Flush Solenoid Valve (8) is larger (1 vs. 3/4 inch). Be sure you install the correct valve. The inlet side of the Back Flush Solenoid Valve (8) will have stainless steel NPT threaded fittings to which you will connect the main incoming water line.

CONNECT DRAIN ASSEMBLY

1. Connect the 3/4 inch diameter Forward Flush Tube (14) to the John Guest Elbow at the bottom of the Lower Tank Assembly (11). Hold the Lower Tank Assembly (11) in your hand when you push the tube in so that you do not apply pressure on the assembly that may break it.
2. Connect the Forward Flush Solenoid Valve (16) to the Forward Flush Tube (14) by screwing it on to the inlet of the solenoid using the solenoid adapter on the end of the Forward Flush Tube (15). Confirm that the flow direction on the solenoid valve is upward by examining the arrow on the solenoid valve body (inlet at bottom, outlet at top). This is extremely important. If installed backwards, the solenoid will not function properly.
3. Connect the solenoid adapter on the bottom of the Drain Assembly (12) to the top of the Forward Flush Solenoid Valve (16).
4. Next, you will connect the Drain Assembly (12) to the drain port of the control valve. Remove the DLFC retaining clip from the left side of the Control

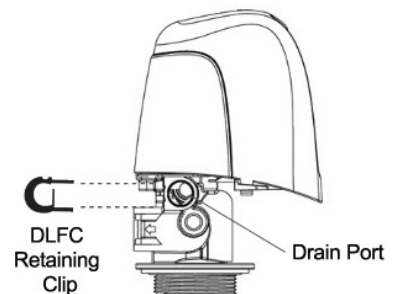

Valve (1). Apply a thin coat of food grade silicone lubricant to the o-ring on the adapter on the end of the Drain Assembly (12) and push it into the drain port of the Control Valve (1). Insert the DLFC retaining clip to secure the Drain Assembly (12).

PLUMBING CONNECTIONS

Before proceeding, align all of the components and tighten all John Guest fittings to make sure the collet has been tightened and the fitting has been secured. Check the solenoid valve connections as well to ensure they all are secure.

If you have a conventional electric water heater or an on-demand (tankless) electric water heater, we highly recommend that you turn off the electricity to the heater while installing any water treatment equipment. Following completion of the entire installation, restore the water flow by turning on the household main water valve and allow all air to be purged from the plumbing system before turning the power back on to your water heater. **Failure to follow this procedure could result in serious, permanent damage to the heating elements in your water heater.**

Turn off the household main water shutoff valve. Open several plumbing fixtures inside the home as well as the outside faucets to drain as much water out of the plumbing system as possible.

Plumb the inlet, outlet and drain connections using suitable plumbing pipe/tubing and fittings. Use only Teflon tape as a sealant on any threads. Do NOT use liquid pipe dope. Be sure to follow all local plumbing codes. The stainless steel adapter on the inlet side of the Back Flush Solenoid Valve can be unscrewed from the solenoid temporarily if it makes the plumbing easier for you.



VERY IMPORTANT:

If you use copper piping and will be soldering the joints, DO NOT apply heat near your Control Valve, Solenoid Valves, or any Assemblies or serious internal damage to these parts could occur. Always solder joints with these components detached.

The drain line should be no less than 3/4" pipe diameter. We recommend that the drain line be connected to a minimum 1 1/2" drain standpipe or floor drain located ideally below the top of the control valve of your system. If possible, the drain should be no farther than 20 feet from the filter system.

While polyethylene tubing or copper pipe is suitable for the drain line, we recommend PEX or rigid PVC or CPVC pipe. If you are using flexible tubing, be sure that there are no "kinks" or "crimps" in the tubing after installation that could cause a flow restriction. If used, overhead drain lines are not to exceed a height of 5 feet above the control valve and should be no more than 50 feet in length. Should an overhead drain line be utilized, it is recommended that the drain line be increased in size (diameter), and that it not be fastened flush to the bottom of a floor joist, to minimize noise transfer during the flush cycles.

Ensure that the drain line is secured along its route to the drain. The drain line will be under pressure when the flush cycles are working, therefore make sure the drain line is well secured so it cannot move around when pressurized. If not adequately secured, the drain line could vibrate during a flush cycle and cause excessive noise. If this is experienced, use additional fasteners to better secure the drain line. The drain line should not be exposed to freezing temperatures.

Note: Never connect the drain line directly into a drain pipe. Allow an air gap between the drain tubing and waste line to prevent the possibility of back-siphoning. We do not recommend use of a check valve as it may become clogged with contaminants ejected from the system during back/forward flush. A minimum air gap of 2x the diameter of the drain line should be provided. Be sure to adhere to the plumbing code applicable in your area.

Place the bypass valve in the "bypass" position as follows by turning the 2 handles:

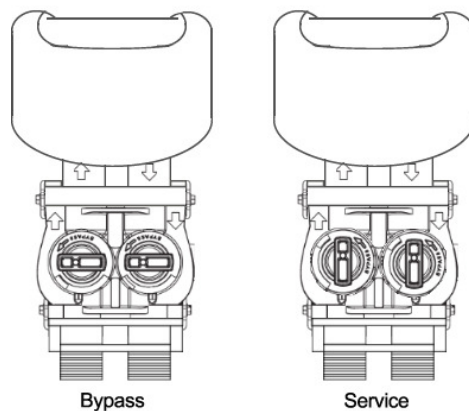

SOLENOID VALVE CONNECTIONS

Note: the Back Flush and Forward Flush solenoids look similar but have different internal functions.

1. Mount the grey Back Flush Solenoid Wiring Kit (9) control box and Forward Flush Solenoid Wiring Kit (17) control box to the wall behind your filter system. Screws and anchors are provided in a plastic parts bag strapped to one of the cables. These 2 control boxes are the same so don't worry which is which until you connect them to the solenoid valves and Control Valve (1) - only the actual solenoid valves are different.
2. Locate the wiring ports on the underside of the left side of the Control Valve (1) head base plate. Remove the valve cover. The port in the front of the valve is for the back flush solenoid and the one in the back is for the forward flush solenoid. The wire(s) from the solenoid control box(es) will be secured to the control valve with a cable gland and nut. These parts are shipped attached to the Control Valve (1).
3. For each solenoid, loosen the cable gland and insert the wire upwards through the cable gland in the Control Valve (1) head base plate.

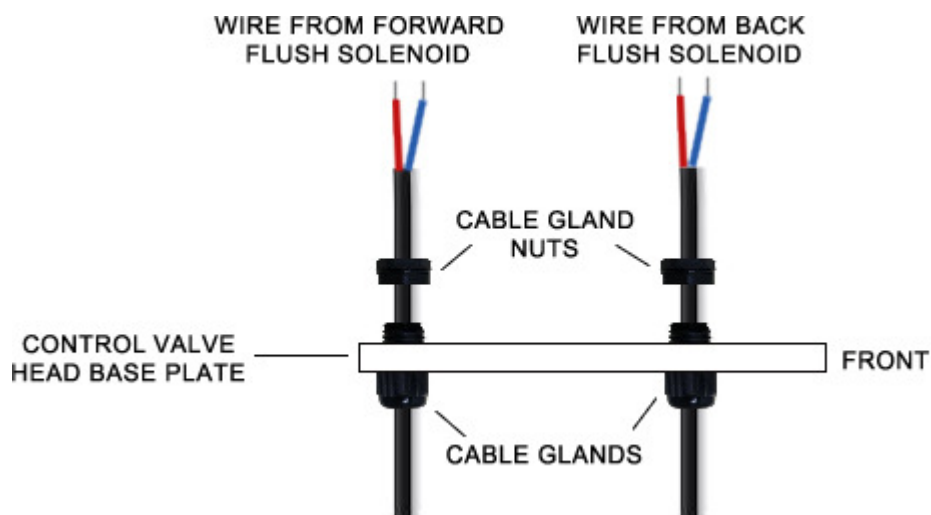
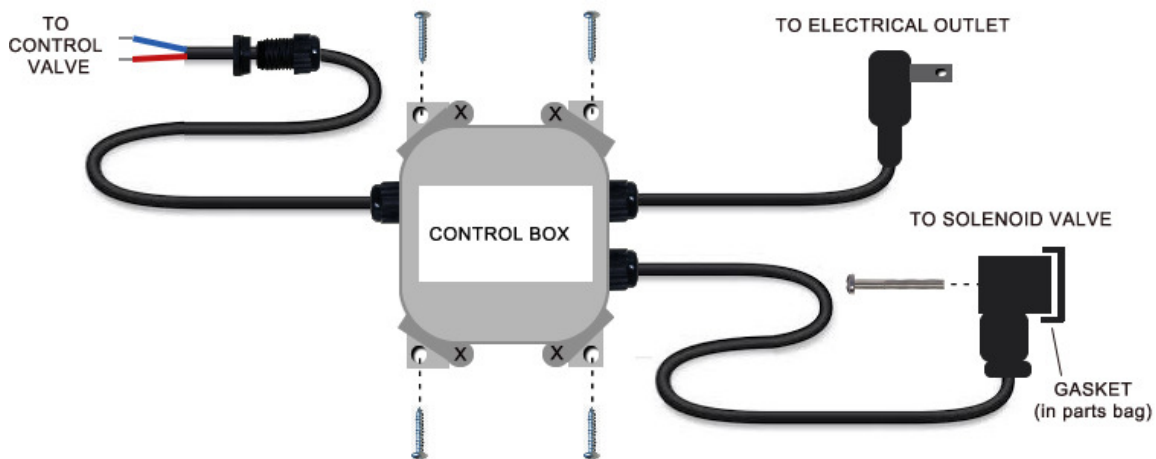

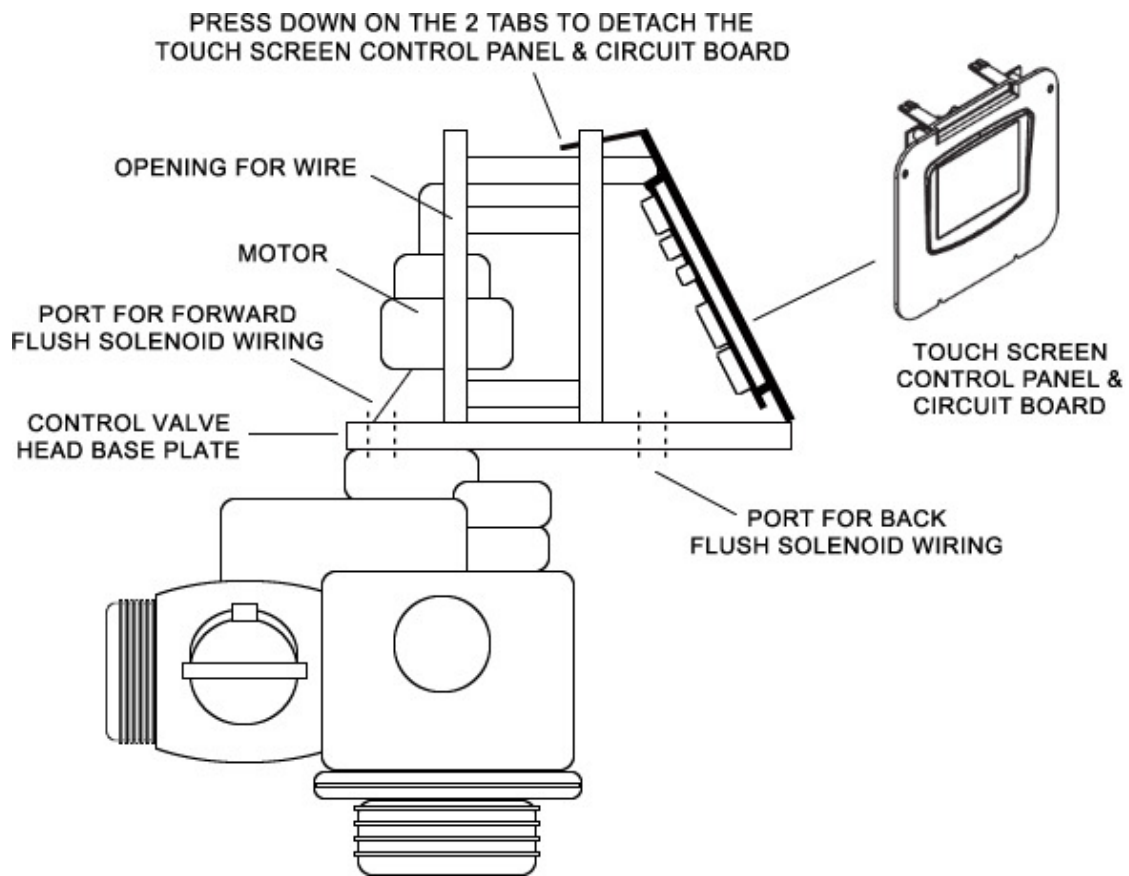

4. Extend the wire(s) forward to the bottom left corner of the touch screen control panel and circuit board. Note the location of the opening in the backplate which can be used to easily pass the wire from the forward flush solenoid control box through to the front of the valve.

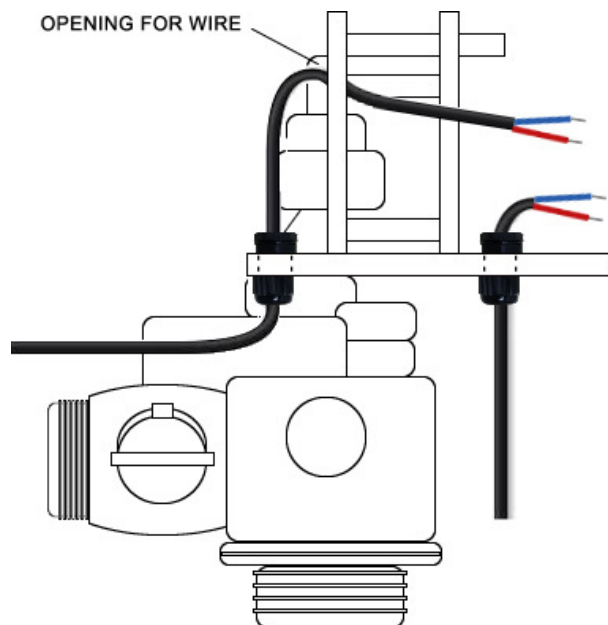

- The touch screen control panel and circuit board can be removed to facilitate access to the back of the circuit board for the final wiring by depressing the 2 tabs at the top of the panel and pulling it forward and upward. Connect the wires from the solenoid control box(es) to the terminal block on the back of the circuit board as noted below and re-connect the touch screen control panel and circuit board by snapping it back into position. Ensure there is a little play in the wires and that none of the wires are pinched, etc. Tighten the cable glands to solidly secure the cables.

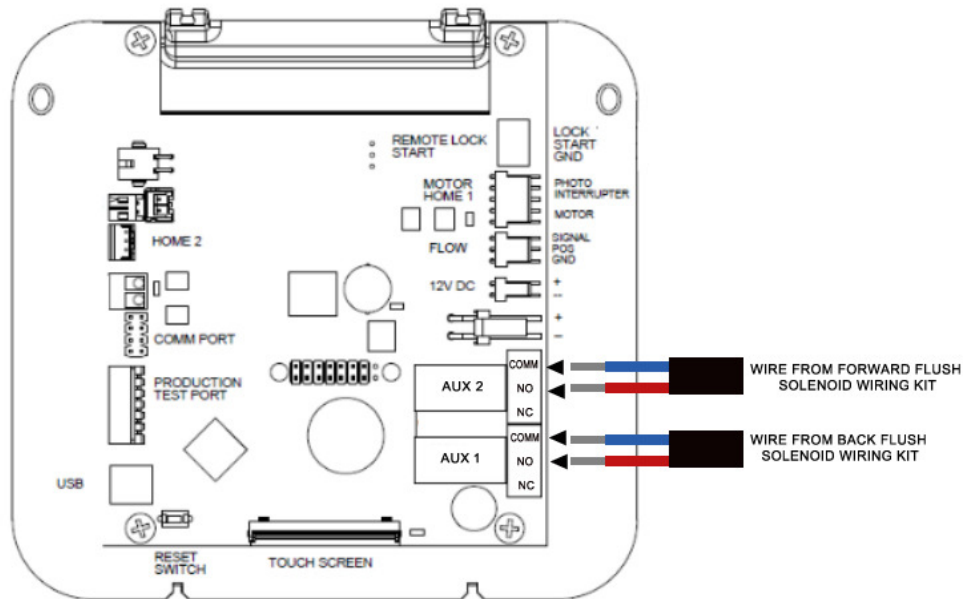

- Connect the solenoid wire(s) from the control box(es) to the solenoid valves. Place the rubber gasket (in parts bag) between the solenoid valve coil (green) and the plug on the end of the wire from the control box. Secure the connection with the screw provided.

START UP THE SYSTEM

The Fleck 5810XTR2 Control Valve (1) comes with a Transformer (2) with a 10 foot long electrical cord. Plug the control valve power cord into the Control Valve (1). **The electrical port on the Control Valve (1) is located on the right side of the valve (when you are facing the control panel), just behind the tab used to remove the valve cover. It is a bit tricky to find... see the diagram to the right:**

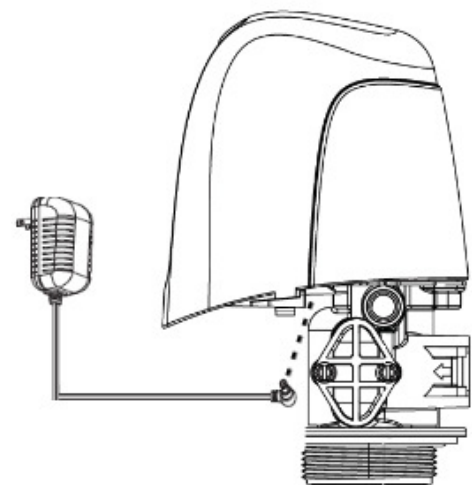

Plug in the power cords from the Solenoid Wiring Kit control boxes, and the Control Valve (1) into standard, grounded 120 volt (60 Hz) electrical outlets. Be certain that the outlets are uninterrupted and not controlled by a

switch. An extension cord may be used to reach a suitable electrical outlet. Ensure that the extension cord is UL/CSA certified and of an appropriate wire gauge for the application.

Once plugged in, the touch screen display on the Control Valve (1) will illuminate. The Control Valve (1) may need to reset its piston to the home position when it is powered up. If it does, the motor will run for a few seconds. This is normal.

The Control Valve (1) has been pre-programmed for you, however, you will need to set the time of day and select the time of day that you prefer for the flush cycle to be done. We normally recommend that the self-cleaning flush cycle be done in the middle of the night when it is unlikely that other water flows will be occurring. The default time is 2:00 am.

The touch screen is shipped with a protective plastic film on it that can be peeled off.

The following is the primary “Home Screen” or Main Menu:

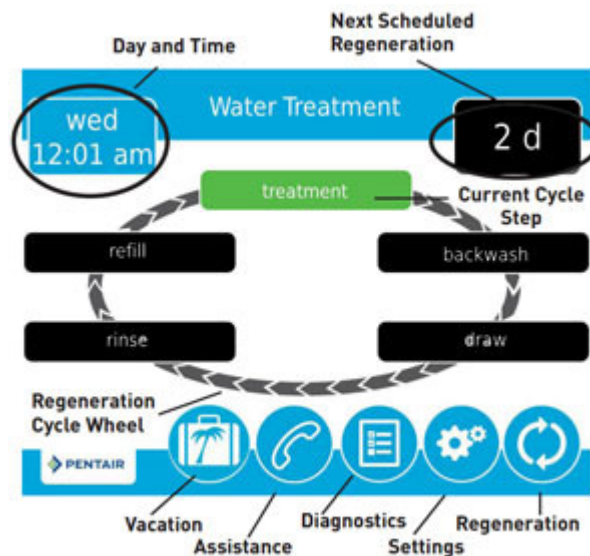

Items displayed in blue or grey can be touched to edit or obtain more information. Items displayed in black are for information purposes only and cannot be selected.

In the top left corner of the screen, you will find the current day of the week and time.

In the top right corner, there is an indicator that will tell you when the next “regeneration” or flush cycle is scheduled to occur.

In the middle of the screen is the regeneration cycle wheel which indicates the current valve cycle (indicated in green), and other applicable cycles (in black).

The bottom menu bar provides the following options:

Vacation: Select this icon to set your water filter system in vacation mode. This mode can be used if you will be away for an extended time and will not be using water. When vacation mode is selected, the system will temporarily cease flush cycles. Upon returning from vacation, it is important to remember to end the vacation mode by pressing the same icon. When in vacation mode, "Vacation Mode" will be displayed in the top right corner of the screen.

Assistance: Select this icon to display the name and phone number of your dealer.

Diagnostics: Select this icon to enter the Diagnostics Mode - see Diagnostics Mode below for more details.

Settings: Select this icon to edit the time of day that the flush cycle will occur. Other programming functions can be accessed using this icon, however, it is strongly recommended that other settings not be modified without first discussing with your dealer.

Regeneration: Select this icon to schedule a flush cycle to occur immediately or next time that time of day equals the regeneration (flush) time.

The touch screen has an energy-saving feature that will turn the display off (sleep mode) if no user input has been made for 5 minutes. To turn the screen back on, just touch it.

TURN ON THE WATER

Ensure that the Bypass Assembly (3) is in the bypass position by turning the 2 handles on the Bypass Assembly (3) so they are perpendicular to the direction of water flow. Turn on the main water supply. Open a cold water tap nearby and let the water run for a few minutes until the system is free of foreign material (usually solder) and air that may have resulted from the installation. Once no more air is discharged, close the water tap. **Inspect your plumbing connections for leaks and repair any leaks found before proceeding.**

Open the bypass valve to the service position. Slowly open a nearby cold water tap (after the treatment system) and let the water run for 5 minutes until the system is purged of all air. The initial flow of water may contain a lot of air bubbles and may even appear milky. This is normal and will go away quickly. Close the water tap and allow the Back Flush Pressure Tank to fill with water. This will take several minutes. **Inspect the system carefully for leaks and repair any leaks found before proceeding.** Open a nearby faucet (hot and cold taps) again and run until all air is purged from the system.

It is now safe to turn the electricity back on to your water heater.

Congratulations! Your system is now ready to provide treated water to your home!

BACK FLUSH AND FORWARD FLUSH

The Back Flush cycle and forward flush cycle are automatically engaged and controlled by your Control Valve (1) and solenoid valve(s). Your system was pre-programmed at the factory.

If you experience reduced service flow rate and pressure loss due to clogging, it is recommended that you increase the frequency and/or duration of your Back Flush. Discuss with your dealer as changes to the Forward Flush cycle might also be recommended.

Step 1: "Backwash" = Back Flush: factory pre-set for 5 minutes at 2 GPM

Step 2: "Rinse" = Forward Flush: factory pre-set for 1 minute.

Unless directed by a water treatment professional familiar with this system, we do not generally recommend that you alter of any of the system programming.

During each step of flush cycle, the digital display on the control valve will indicate the cycle currently underway and the amount of time remaining in that cycle.

SETTING THE TIME OF DAY

The current day of the week and time is displayed in the top left corner of the home screen. It is important that the day and time be accurate so that the flush cycle(s) will occur at the correct time of the day and so that the diagnostic and data gathering functions of the control valve will be accurate.

If the day and time are flashing, it means that there has been a power failure and the day and time need to be checked.

To change the time of day, touch the day and time display in the top left corner of the home screen and the following screen will appear:

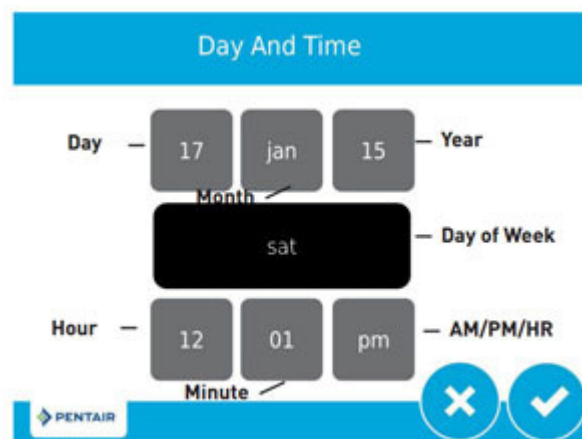

Touch the grey box associated with the year. 2 blue arrows will appear. Touch the blue arrow on the left to decrease the year. Touch the blue arrow on the right to increase in the year. Adjust the year by touching the arrows until it is correct.

Similarly, touch the grey boxes associated with the month and day and use the arrows to adjust the month and day settings until they are correct

Set the hour, minutes, and pm/am in the same manner.

When you are satisfied that all of the settings are correct, press the checkmark icon in the bottom right corner of the screen. To cancel your changes and return to the home screen, press the “X” icon at any time.

CHANGING BASIC SETTINGS

The Settings Mode allows you to set the frequency of the back flush and the time of day that the flush cycles will take place. You can also adjust the brightness of the touch screen display.

To the Settings Mode, touch the settings icon in the main menu at the bottom of the home screen. The following screen will appear:

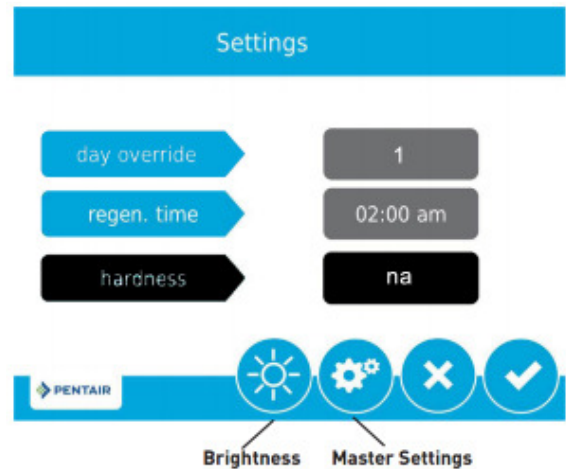

Touch Screen Display Brightness

You can adjust the brightness of your touch screen by touching the brightness icon. The brightness can be set on a scale from 0 to 10 with 10 being the brightest. The default setting is 10. To change the setting, touch “power,” then use the 2 blue arrows to increase or decrease the brightness to suit your preferences. Each time you press one of the blue arrows, the screen brightness will change accordingly.

When you are satisfied with the brightness level, press the checkmark icon in the bottom right corner of the screen. To cancel your changes and return to the home screen, press the “X” icon at any time.

Flush Cycle Time

The “regen. time” is the time of day that the automatic flush cycle(s) are scheduled to be done. We recommend that the flush cycles be carried out in the middle of the night or other time where it is unlikely that water will be used for other purposes.

To adjust the time of day that the flush cycles will occur, touch “regen. time” and two blue arrows will appear. Touch the arrow on the left to adjust to an earlier time, and the arrow on the right to adjust to a later time.

When you are satisfied that all of the settings are correct, press the checkmark icon in the bottom right corner of the screen. To cancel your changes and return to the home screen, press the “X” icon at any time.

Day Override

The default setting is 1. We do not recommend that you adjust this setting.

Master Settings

The Master Settings Mode allows service technicians to set-up the valve for optimal performance. A password is required to enter this mode. We do not recommend that you alter any of these settings. See Master Settings Mode below.

DIAGNOSTICS

The Diagnostics Mode allows you to view a wide range of information about the performance of your system and your water usage. Note: data about water flow rates and water usage is only available if you purchased an optional flow meter than is not included as standard equipment with your system. You can enter the Diagnostics Mode by selecting the diagnostics icon in the main menu on the home screen.

Once in the Diagnostic Mode, you can navigate to the next screen by pressing the right arrow in the top right corner of the screen or go back to the previous screen by pressing the left arrow in the top left of the screen. You can return to the home screen at any time by pressing the home icon in the bottom right corner of the screen.

The first screen displays the following diagnostic information:

Flow Rate: This is the current flow rate of water through the system in gallons per minute. If water is not running, it will display 0.0 GPM. NOTE: This feature is only enabled if you purchased an optional flow meter for your system.

Peak Flow: This is the highest flow rate in gallons per minute recorded through the system since measurement was last reset. To obtain more details, touch “peak flow” and it will display the date and time at which this peak flow rate occurred. NOTE: This feature is only enabled if you purchased an optional flow meter for your system. To reset the peak flow meter, select the icon

in the bottom right corner of this screen. The peak flow rate meter will be reset to zero. To return to the main diagnostics screen without resetting the meter, press the diagnostics icon instead.

Totalizer: This is the total volume of water in gallons (US) that have been treated by the system since the totalizer meter was last reset. NOTE: This feature is only enabled if you purchased an optional flow meter for your system. To reset the peak flow meter, touch “totalizer” and then select the icon in the bottom right corner of the next screen. The totalizer meter will be reset to zero.

The second screen displays when the last regeneration (flush cycle) occurred as well as the software version that is used by your control valve.

The third screen indicates the number of flush cycles that the valve has done as well as the average interval between regenerations (flushes) based on the last 4 cycles.

Daily Usage: In this area, you can access daily water usage information for the past month. The first screen allows you to see the average water usage by day of the week (use the > and < icons to view other days of the week). Select a day of the week to see detailed water consumption data on this day of the week for the last month. NOTE: This feature is only enabled if you purchased an optional flow meter for your system.

The final Diagnostic Mode screen provides details as to how much water has been processed since the last flush cycle and when the programming settings were last changed. NOTE: This feature is only enabled if you purchased an optional flow meter for your system.

To exit the Diagnostics Mode, press the home icon in the bottom right corner of the screen.

MASTER SETTINGS MODE

The Master Settings Mode is designed for professional use only. Unless directed by a water treatment professional familiar with the system, it is not recommended that any of the Master Settings Mode settings be modified.

To enter the Master Settings Mode, select the “Settings” icon from the home screen, then select the “Settings icon” again. The Password is: 1201

The following settings are the factory default settings for standard UltraPlus+ systems:

FORMAT

Parameter	Setting
language	english
units	us

hardness units	gpG
----------------	-----

VALVE

Parameter	Setting
system	4
valve	5800
regen. type	Time Clock
day override / time driven	1
regen. time	2:00 am

REGEN.

Parameter	Setting
regen flow	filter
step # 1	backwash
time 1	5 m
step # 2	rapid rinse
time 2	1 m

RELAY

Parameter	Setting
auxiliary 1	cycle based
auxiliary 2	cycle based
Aux. 1 Cycle Based	
treatment	off
rapid rinse	off
backwash	on
draw	na
tank refill	na
pause	na
Aux. 2 Cycle Based	
treatment	off
rapid rinse	on
backwash	off
draw	na
tank refill	na
pause	na

CONTROL OPERATION DURING A POWER FAILURE

The 5800XTR2 valve/controller includes integral power backup. In the event of power failure, the control shifts into a power-saving mode. The control stops monitoring water usage, and the

display and motor shut down, but it continues to keep track of the time and day for a minimum of 48 hours.

The system configuration settings are stored in a non-volatile memory and are stored indefinitely with or without line power. The day of the week and time of day display flashes when there has been a power failure.

If power fails while the unit is in a flush cycle, the control will save the current valve position before it shuts down. When power is restored, the control will resume the cycle from the point where power failed. Note that if power fails during a flush cycle, the valve will remain in its current position until power is restored. The drain line plumbing configuration should include all required safety components to prevent overflows resulting from a power failure during backwash.

The control will not start a new flush cycle without power. If the valve misses a scheduled flush cycle due to a power failure, it will queue one for the next day. Once power is restored, the control will initiate a cycle the next time that the time of day equals the programmed cycle time.

MAINTENANCE & TROUBLESHOOTING

WARNING: The controller MUST be depressurized before removing any quick connection clips or removing the valve for servicing or membrane replacement.

Service Recommendations

Your Fleck 5800 Control Valve (1) is built for long term operation with limited maintenance. The seals and spacers and piston assembly require periodic servicing or replacement, usually every 3 to 5 years. A service professional should be contacted for this maintenance.

Part Required: Fleck 5800 Piston and Seal Kit Assy, Downflow (Part #61837)

The Membrane Vessel (4) has a finite service life ranging from 5 to 10 years in most applications. Significantly reduced flow performance that cannot be resolved by membrane cleaning is the most common sign that the membrane has reached the end of its service life. The Membrane Vessel (3) can be cleaned to extend its service life. Common cleaning agents include:

- Chlorine (sodium hypochlorite) to break-up bio films
- Acid wash to remove iron and manganese, and hard water mineral fouling
- Soda ash wash to remove organic fouling

Membrane cleaning should be performed by a water technician.

Running extra Back Flush cycles can help unclog a clogged membrane.

Troubleshooting

See page 17 of the control valve manual for troubleshooting tips.

WARRANTY INFORMATION

Your system components, other than the media, are warranted by HomePlus Products Inc. to be free of defects in material and workmanship for the following periods from the date of purchase provided that your system was purchased from an Authorized dealer; operated in accordance with operating conditions stated herein; and provided that it was installed in accordance with these instructions:

Membrane Vessel: 3 Years, Pro-Rated

Control Valve: 5 years

Back Flush Pressure Tank (Wellmate WM-9): 5 years (residential only)

All Other Components: 1 year

This warranty applies only in Canada and the United States of America.

In the event that a part is deemed defective, the user must immediately inform HomePlus Products Inc. who will furnish a replacement part at no cost to the user (subject to pro-rated coverage of the Membrane Vessel).

This warranty does not cover shipping costs or any labour costs related to troubleshooting, installation, or maintenance.

The warranty does not apply to the following situations: misuse; normal wear and tear; neglect; unauthorized repair or damage caused through installation, adaptation, or modification; use in an improper manner or manner inconsistent with these operating and maintenance instructions; wear or deterioration due to environmental conditions; damage occurring during transit; mishandling; improper storage; incorrect supply of water; tampering or alteration; act of god; or any cause beyond the control of HomePlus Products Inc.

The original warranty period does not change in the event of part replacement by HomePlus Products Inc.

The warranty is issued exclusively to the original consumer purchaser of record and is not transferable.

The provisions of the foregoing warranty are in lieu of any other warranty, whether express or implied, written or oral (including any warranty of merchantability or fitness for a particular purpose). HomePlus Product Inc.'s liability arising out of the manufacture, sale, or supplying of the products or their use or disposition, whether based upon warranty, contract, tort, or

otherwise, shall not exceed the actual purchase price paid by the authorized distributor or consumer for the product. In no event shall HomePlus Products Inc. be liable to the distributor or any other person or entity for special, incidental, consequential or punitive damages (including, but not limited to, property loss, loss of incomes, or loss of use damages) arising out of the manufacture, sale, or supplying of the products, even if HomePlus Products Inc. has been advised of the possibility of such damages or losses.

HomePlus will not be liable under this warranty for any fault or damage arising from defective workmanship if the product has been modified by any person other than HomePlus Products Inc.

Proof of purchase is required for warranty service.

**To report a warranty problem with your system, please call HomePlus Products Inc.
Toll free: 1-866-376-2690**

MANUFACTURED BY:



HomePlus Products Inc.

**5-1490 Pearson Place
Kamloops, BC V1S 1J9 Canada**

Phone: 250-374-2690

Fax: 250-374-2692

www.homeplusproducts.com